

SERVICE MANUAL

ADCOM[®]

POWER AMPLIFIER

GFA-555 II

TABLE OF CONTENTS

Introduction	1
Test Procedures	2
Service Parts List	3
Audio Input/Driver PCB	7
Filter Capacitor PCB	7
Optional Fan Motor PCB	7
Left Channel Output PCBs	8
Right Channel Output PCBs	9
Typical Performance Data	10
Specifications	12
Schematic	14

ADCOM[®]

ADCOM

15953 Greenway-Hayden Loop Ste H
Scottsdale AZ 85260
(480)607-2277
(480)348-9876 Fax

INTRODUCTION

This service manual is intended to assist trained and qualified technical personnel in verifying the performance of, adjusting, and repairing the ADCOM GFA-555II power amplifier. The procedures described here are not intended for persons unfamiliar with the appropriate safety and test procedures.



WARNING



THERE ARE POTENTIALLY LETHAL VOLTAGES WITHIN THE GFA-555II AMPLIFIER WHICH WILL BE ACCESSIBLE ONCE ITS TOP COVER IS REMOVED. DO NOT ATTEMPT FAMILIARIZATION, INSPECTION OR ANY PROCEDURE WHATSOEVER UNLESS YOU HAVE DISCONNECTED THE GFA-555II FROM THE WALL AC OUTLET OR OTHER SOURCE OF AC POWER AND THE POWER-SUPPLY CAPACITORS ARE COMPLETELY DISCHARGED. PLEASE TAKE NOTE THAT THE POWER-SUPPLY CAPACITORS TAKE AS LONG AS 5 MINUTES TO DISCHARGE. THESE INSTRUCTIONS ARE PROVIDED FOR USE ONLY BY COMPETENT TECHNICAL PERSONNEL. DO NOT UNDERTAKE ANY SERVICE PROCEDURES IN THE GFA-555II UNLESS YOU ARE TECHNICALLY QUALIFIED TO DO SO.

CIRCUIT DESCRIPTION

The ADCOM GFA-555II is a stereo power amplifier rated at less than 0.04% THD from 20Hz to 20kHz with 200 watts into 8 ohms and 325 watts into 4 ohms. The output stage is capable of greater than 60 amps into low impedance loads. The amplifier employs a discrete differential Class-A front-end followed by a Class-A voltage gain stage which amplify the input signal to the voltage required at the output of the amplifier. This high-voltage signal drives the high-current triple-Darlington-follower output stage which amplifies the current by a factor of about 50,000.

Referring to the accompanying schematic, describing the Left Channel only, the input signal passes through network C101, C102 and R103 which provide a 3dB bandwidth of 1.7Hz to 500kHz to the input of the amplifier. C101 is an extremely high quality capacitor and serves to protect the amplifier and the speakers connected to it from DC faults at the output of the preamplifier. **WE DO NOT RECOMMEND THAT C101 BE SHORTED OUT.** Q101 and Q102 form the differential input stage.

Open-loop gain is defined by R105 and the bias current through Q101 and Q102. The small-signal gain is approximately $825/(2 \times 25) = 16$. The next voltage gain stage consists of Q107 with Q108 as a current-source load. DC bias is set by R116, D103 and D104. Open-loop gain is defined by R112 and R113, with R201, R301, C105, C201, and C301 providing high-frequency compensation.

Feedback is provided from the output to the base of Q102 by the network R123, R124 and C106. C106 provides a high-frequency roll-off above 200kHz, improving stability by taking high-frequency feedback before the triple Darlington.

The input stage is biased by R108, R109, R110, R122, R115, R114, R128, R116, Q103, Q105, Q108, D101 through D105, and the overtemperature LED, D903. Q105 is turned on when the B+ supply is on. A current of about 4mA flows through the thermal breaker on the heatsink and into D103 and D104. If the heatsink overheats, the breaker opens and the current flows through D105 and the THERMAL OVERLOAD LED instead. When the breaker carries the current, D103 and D104 are biased at 1.4V. This creates about 0.7V across R114; Q103 then sources about 2mA to Q101 and Q102, the differential input stage. If the negative supply fails or its fuse opens, Q103 saturates, Q101 turns off, turning off Q107, D301 turns on and Q108 saturates. This holds the input to the triple Darlington to near ground. If the positive supply fails or its fuse opens, Q105 turns off and the bias circuitry is disabled.

Any DC imbalance in the amplifier is corrected by R125, R126, R127, C107, C110 and IC101. Any DC error at the amplifier output is servoed back through IC101 to adjust the DC current through the input transistors. DC bias is nominally 1.0mA through Q101 and Q102. IC101 provides the DC bias current to Q101 and can swing from ground to +10V to bring the amplifier into balance.

The bias network of R117 through R119 and Q307 form a temperature-compensated DC-bias voltage to the input of the triple-Darlington-follower output stage. Mid- and high-frequency bypassing is provided by C104.

R901 and C901 provide a load for the amplifier at high frequencies, stabilizing the amplifier under varying load conditions. D201 and D301 provide a high-current return to the power supply for backlash current from the load. The output stage consists of two sets of 4 parallel transistors operated as emitter followers, driven by another pair of emitter followers. This configuration minimizes distortion caused by varying load impedances. The output transistors have 0.22-ohm ballast resistors to ensure current sharing and bias stability.

TEST PROCEDURES

All tests are performed with a 120V, low-distortion (less than 2%), AC-power source, 8-ohm resistive load, (except slew rate), and a signal source of not more than 600 ohms.

Tests are performed after warming up the amplifier at 66 watts into an 8-ohm load for at least 10 minutes.

All grounds during testing are referred to the ground of the black output terminals, **EXCEPT FOR RCA INPUT-JACK GROUNDS AND ANY SIGNAL-GENERATOR GROUND. DO NOT CONNECT RCA INPUT-JACK GROUNDS TO BLACK OUTPUT-TERMINAL BINDING POSTS, DAMAGE TO THE GROUNDING SYSTEM OF THE AMPLIFIER MAY RESULT.**

80kHz low-pass filter is employed during THD distortion measurements.

Signal-to-noise measurements are "A" weighted.

Damping factor is measured by comparing the 20-watt-output voltage with and without an 8-ohm load.

Slew rate is measured with an inductive load, and is derived with a dual-time-based oscilloscope reading the slope of a full-power (120V peak-to-peak) 5kHz square wave. To avoid damaging output networks R901/C901 AND R951/ C951 **DO NOT OPERATE THE AMPLIFIER AT FULL-POWER, SINE-WAVE ABOVE 22kHz OR FULL-POWER (120V PEAK-TO-PEAK) SQUARE WAVE ABOVE 5kHz.**

IMPORTANT

BEFORE PROCEEDING WITH ADJUSTMENTS, MAKE SURE AMPLIFIER IS AT ROOM TEMPERATURE.

BIAS ALIGNMENT

1. With set-up as per the first paragraph of TEST PROCEDURES and with NO SIGNAL IN, set bias controls (R119 and R169) to midpoint.
2. Connect a millivolt meter across TP201 and TP301.
3. Turn amplifier on and allow a 3 to 5 minute settling period.
4. Adjust BIAS control R119 to obtain either a + or - 10mV (± 1 mV) indication on the millivolt meter.
5. Connect a millivolt meter across TP251 and TP351.
6. Adjust BIAS control R169 to obtain either a + or - 10mV (± 1 mV) indication on the millivolt meter.
7. To check for proper bias setting, remove millivolt meter and apply input signal to obtain 66 watts into 8 ohms for 10 minutes with cover on.
8. Remove input signal and connect the millivolt meter as in Step 2 and step 5. Let amplifier idle until bias stabilizes and readjust to 10mV (± 1 mV).

ADCOM GFA-555II SERVICE PARTS LIST

1. AUDIO INPUT/DRIVER PCB ASSEMBLY



INTEGRATED CIRCUITS

IC101, IC151 ADCOM 3A

TRANSISTORS:

Q101, Q102, Q151, Q152 2SC2362(K)(G)
 Q103, Q153 2SC2240
 Q104, Q106, Q154, Q156 2SA1016(K)(G)
 Q105, Q107, Q155, Q157 2SA1210
 Q108, Q158 2SC2912

DIODES:

D101, D102, D103, D104,  1SS178
 D151, D152, D153, D154 
 D105, D155 1SS81



DIODES, ZENER:

D106, D156 GZA20X 20 VOLT

CAPACITORS, ELECTROLYTIC:

C104, C154 50V/4.7uF
 C109, C159 25V/470uF

CAPACITORS, FILM:

C103, C153 100V/0.1uF
 C107, C108, C110,  50V/0.1uF
 C157, C158, C160 
 C101, C151 100V/1uF  ROEDERSTEIN MKC 1862
 ELECTRONIC CONCEPTS SMC22B105K

CAPACITORS, MICA:

C102, C152 100V/330pF
 C105, C155 500V/15pF
 C106, C156 500V/50pF



RESISTOR, VARIABLE:

R119, R169 41-7126-0-0 2000 OHMS

RESISTORS, OXIDE METAL-FILM, 5%:

R104, R154 1/2W/100 ohms
 R107, R157 1/2W/3.9 kohms

RESISTORS, METAL-FILM, 1%:

R101, R151 1/4W/1 Mohms
 R102, R152 1/4W/100 kohms
 R103, R111, R124,  1/4W/1 kohms
 R153, R161, R174 
 R105, R155 1/4W/825 ohms
 R106, R156 1/4W/365 ohms
 R108, R158 1/4W/47.5 kohms
 R109, R123, R159, R173, R180 1/4W/22.1 kohms
 R110, R160 1/4W/133 ohms
 R112, R113, R162, R163 1/4W/33.2 ohms
 R114, R164 1/4W/301 ohms
 R115, R122, R165, R172 1/4W/10 kohms
 R116, R166 1/4W/100 ohms
 R117, R167 1/4W/381 ohms
 R118, R168 1/4W/1.82 kohms
 R126, R176 1/4W/1.5 Mohms
 R128, R178 1/4W/475 ohms
 R129, R179 1/4W/33 kohms

RESISTORS, FUSIBLE, 5%

R120, R121, R170, R171 ¼W/100 ohms

RESISTORS, CARBON-FILM, 5%

R125, R127, R175, R177 ¼W/4.7 Mohms

THERMOSTATS:

S101, S151 Δ 81-7014 UP62, 85° C

SWITCH:

S102 81-322-0-0 B22JH

2. LEFT CHANNEL OUTPUT PCB ASSEMBLIES**TRANSISTORS:**

Q201 2SC2912

Q202 2SD1047

Q203, Q204, Q205, Q206 2SD424

Q301 2SA1210

Q302 2SB817

Q303, Q304, Q305, Q306 2SB554

Q307 2SC2240

DIODES:

D201, D301 EPG50D

CAPACITORS, MICA:

C201, C301 500V/68pF

CAPACITORS, ELECTROLYTIC:

C202, C302 160V/47uF ECEA2AGE-470

RESISTORS, OXIDE METAL-FILM:





R202 ½W/470 ohms

R203, R302 ½W/1 kohms

R204 ½W/33 ohms

RESISTORS, METAL-FILM:

R201, R301 ¼W/47 ohms

R205, R207, R209, R211,  ¼W/10 ohmsR303, R305, R307, R309  ¼W/10 ohms**RESISTORS, CEMENTED WIRE-WOUND:**R206, R208, R210, R212,  2W/0.22 ohmsR304, R306, R308, R310  2W/0.22 ohms**THERMISTOR:**

TH901 TD5-C310DA

3. RIGHT CHANNEL OUTPUT PCB ASSEMBLIES**TRANSISTORS:**

Q251 2SC2912

Q252 2SD1047

Q253, Q254, Q255, Q256 2SD424

Q257 2SC2240

Q351 2SA1210

Q352 2SB817

Q353, Q354, Q355, Q356 2SB554

DIODES:

D251, D351 EPG50D

CAPACITORS, MICA:

C251, C351 500V/68pF

CAPACITORS, ELECTROLYTIC:

C252, C352 160V/47uF ECEA2AGE-470

RESISTORS, OXIDE METAL-FILM:R252 1/2W/470 ohms
R253, R352 1/2W/1 kohms
R254 1/2W/33 ohms**RESISTORS, METAL-FILM:**R251, R351 1/4W/47 ohms
R255, R257, R259, R262,  R353, R355, R357, R359 1/4W/10 ohms**RESISTORS, CEMENTED WIRE-WOUND:**R256, R258, R261, R263, 2W/0.22 ohms
R354, R356, R358, R360**THERMISTOR:**

TH902 TD5-C310DA

4. FILTER CAPACITOR PCB ASSEMBLIES**RESISTORS, OXIDE METAL-FILM:**R801, R802, R803, R804 3W/3.9 kohms
R805 2W/8.2 kohms**CAPACITORS, FILM:**

C806, C807, C808, C809 100V/0.01uF

5. CHASSIS-MOUNTED COMPONENTS**AC POWER SWITCH:**S801 Δ 12005C BLACK, CARLING RGSCC-711-R-B-B-O
 Δ 12005CW WHITE, CARLING RGSCC-711-R-W-W-O**POWER TRANSFORMER:**T801 Δ 23-2044-0-0 ADCOM**CAPACITORS, ELECTROLYTIC:**C802, C803, C804, C805 Δ 100V/15000uF ADCOM**CAPACITORS, FILM:**

C901, C951 100V/0.01uF

CAPACITORS, SPARK-KILLER:C801 Δ 400V/0.01uF ECKDNS103ZV**RESISTORS, OXIDE-METAL FILM, 5%:**

R901, R951 2W/10 ohms

SILICON RECTIFIERS:D801, D802 Δ 400V/25A KBP2504**RCA JACKS:**

J901, J951 VTW-J5MI ADCOM

SPEAKER TERMINALS:J902, J952 R33729 RED, ADCOM
J903, J953 B33729 BLACK, ADCOM

FUSE HOLDERS:

FH801	FH052
FH802, FH803, FH804, FH805	FH032

FUSES:

FU801 (120V UNIT)*	△ ABC-12/250V 3AB314012/250V CES6-12A/125V	BUSSMAN LITTELFUSE SOC
FU801 (220V UNIT)*	△ AGC-7/250V 3AG312007/250V	BUSSMAN LITTELFUSE
FU801 (240V UNIT)*	△ AGC-6/250V 3AG312006/250V CES14-6A/250V	BUSSMAN LITTELFUSE SOC
FU802, FU803, FU804, FU805*	△ AGC-7/250V 3AG312007/250V 3AG 7A/125V	BUSSMAN LITTELFUSE BEL

LEDs:

D803	LTL2201	RED, POWER INDICATOR
D903	LTL2201	RED, THERMAL PROTECTION
D901, D902	LTL2251	YELLOW, INSTANTANEOUS DISTORTION ALERT

6. POWER SUPPLY PCB ASSEMBLY FOR OPTIONAL FAN MOTOR, ISSUE "B"

INTEGRATED CIRCUITS:

IC601	NJM4558
IC602	NJM78M24FA

TRANSISTORS:

Q601	2SA1469R
------	----------

DIODES:

D601	1SS178
D602	DBA10B

CAPACITORS, ELECTROLYTIC:

C601	50V/10uF
C602	35V/1000uF

RESISTORS, CARBON-FILM, 5%:

R601, 604	1/4W/7.5 kohms
R602	1/4W/9.1 kohms
R603, R605, R606	1/4W/24 kohms
R607	1/4W/150 kohms
R608	1/4W/10 kohms
R609	1/4W/1 kohms

* The fuses listed, and their time-current blowing points, have been carefully selected and thoroughly tested to deliver optimal performance while still accomplishing their protective functions. Replace these fuses, individually, only with the specific types listed. **DO NOT USE ANY SUBSTITUTE FUSES WITH DIFFERENT RATINGS, TIME-CURRENT CURVES OR VALUES.** These may cause serious damage to the amplifier circuits and **MAY CREATE A FIRE HAZARD.**

△ Because of fire, shock and/or other hazards, parts identified by, and listed with, this sign **MUST** be replaced with the **IDENTICAL FACTORY PART** listed in the SERVICE PARTS LIST. No substitutions with other "equivalent" parts can be made.

GFA-555II AUDIO INPUT/DRIVER PCB ASSEMBLY

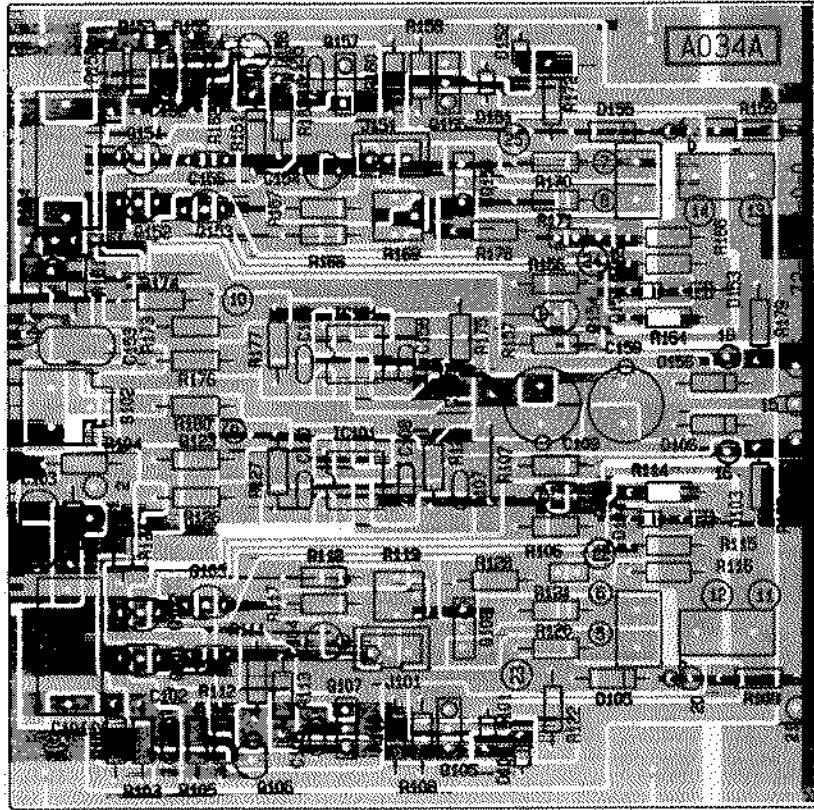

GFA-555II FILTER CAPACITOR PCB ASSEMBLIES

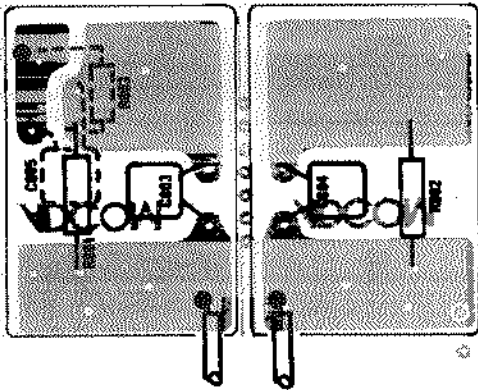

GFA-555II POWER SUPPLY PCB ASSEMBLY FOR OPTIONAL FAN MOTOR, ISSUE "B"

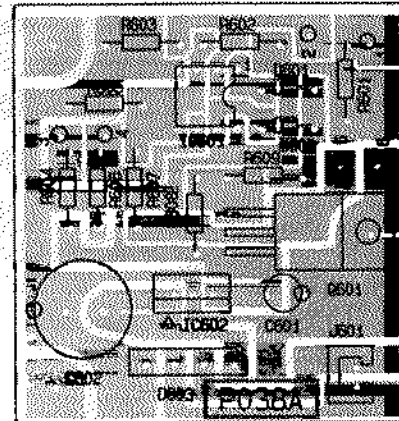

GFA-555II LEFT CHANNEL NPN OUTPUT PCB

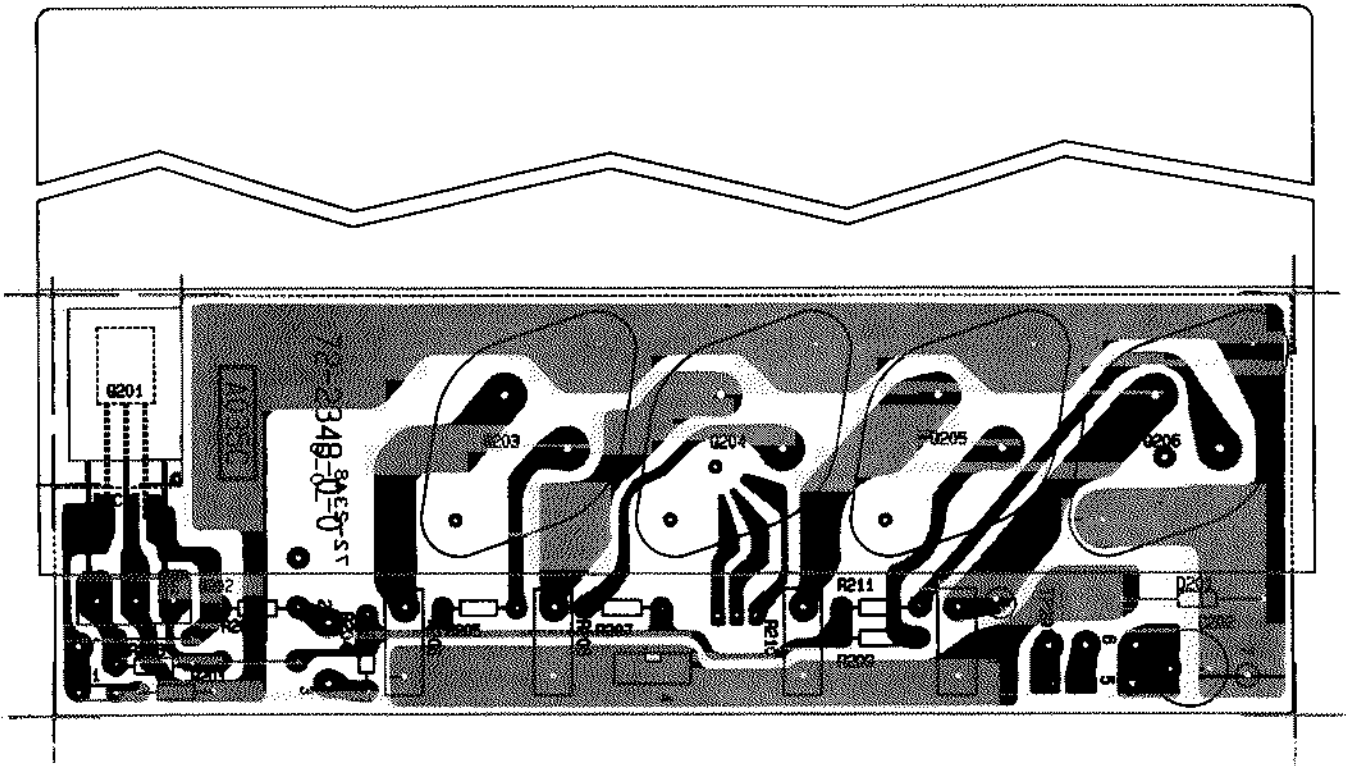

GFA-555II LEFT CHANNEL PNP OUTPUT PCB

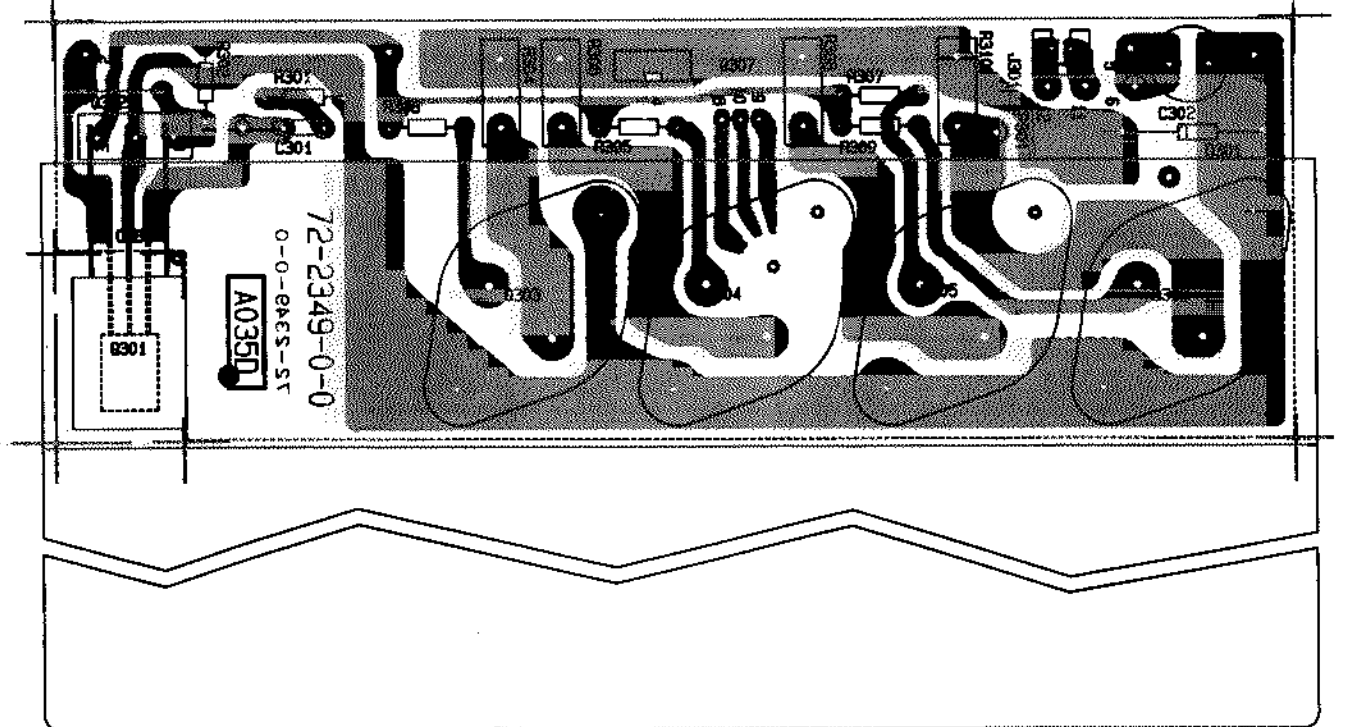

GFA-555II RIGHT CHANNEL NPN OUTPUT PCB

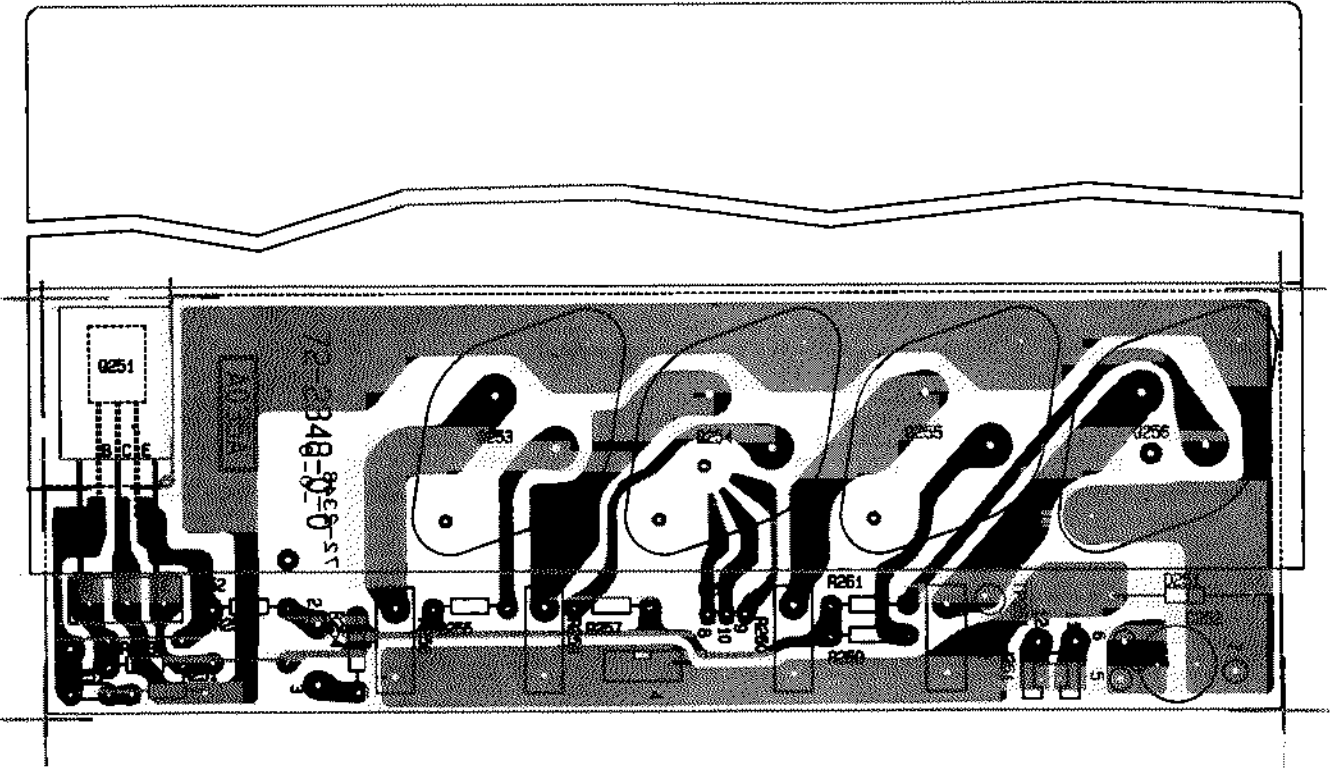

GFA-555II RIGHT CHANNEL PNP OUTPUT PCB

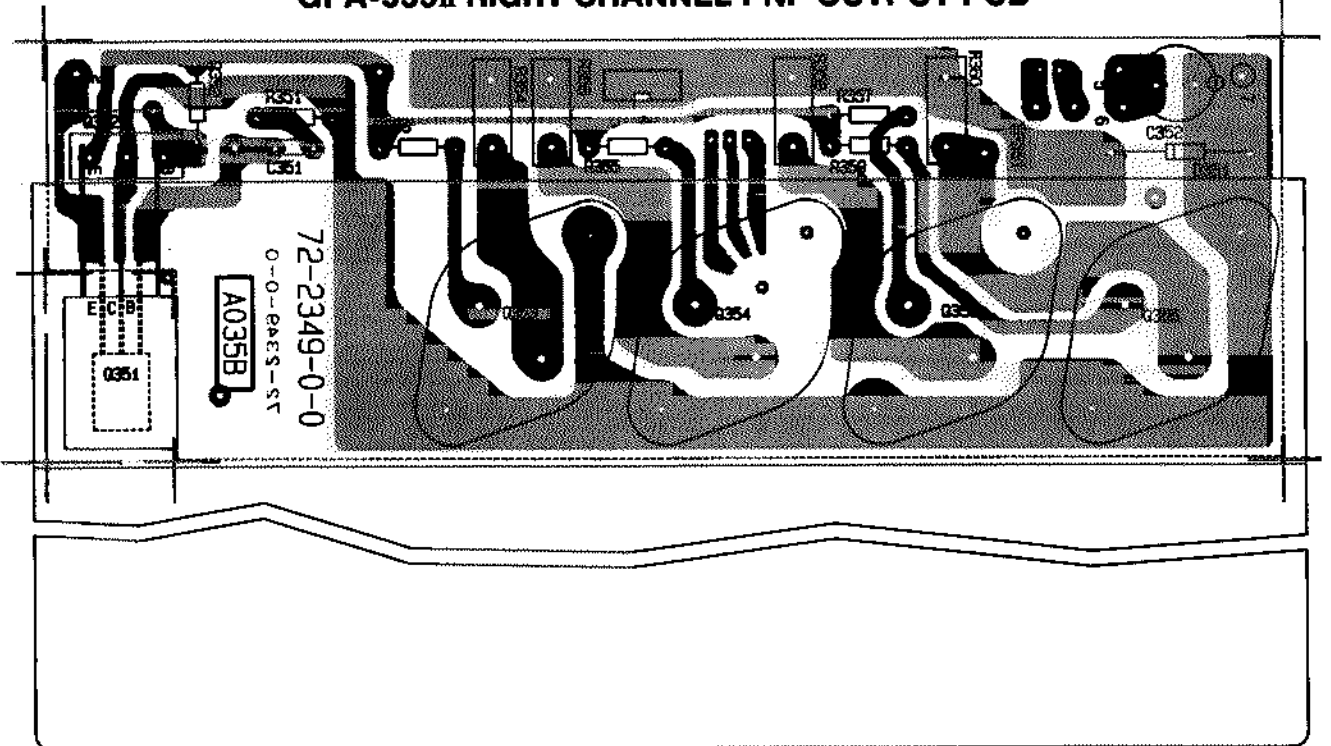

GFA-555II TYPICAL PERFORMANCE DATA

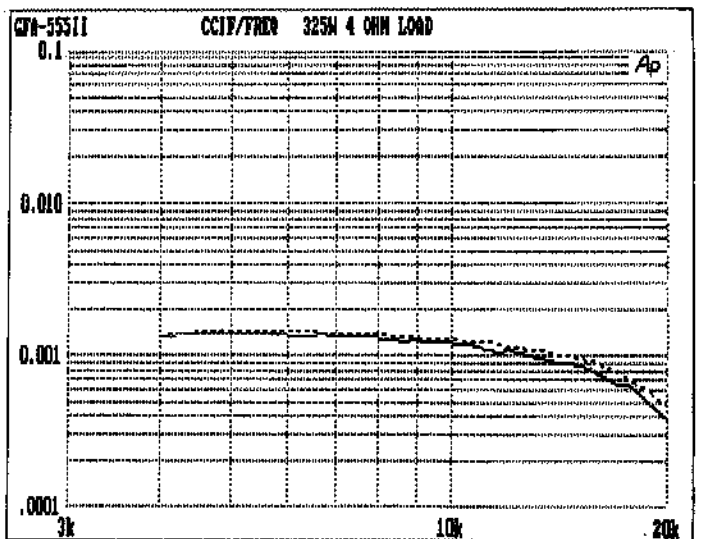
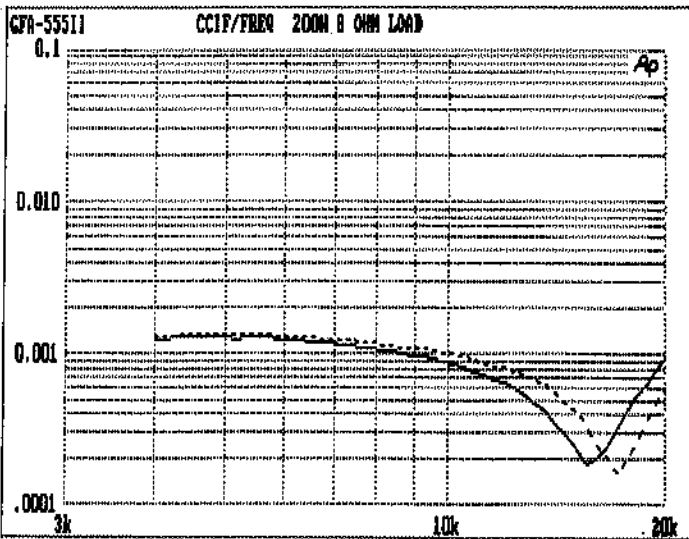
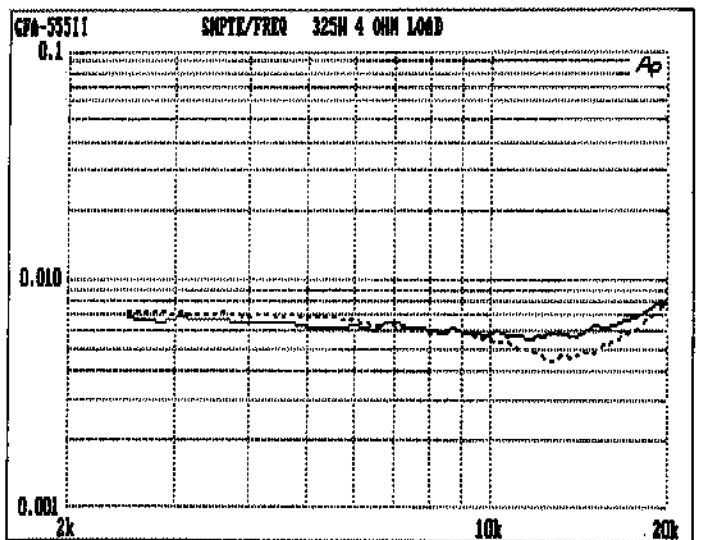
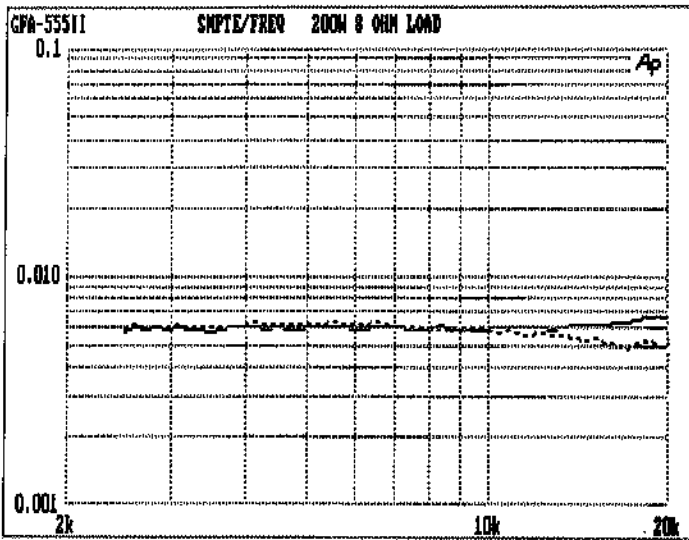
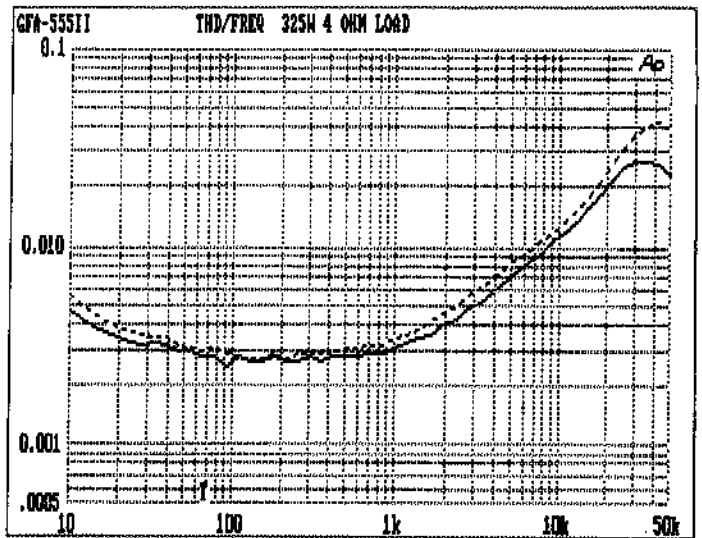
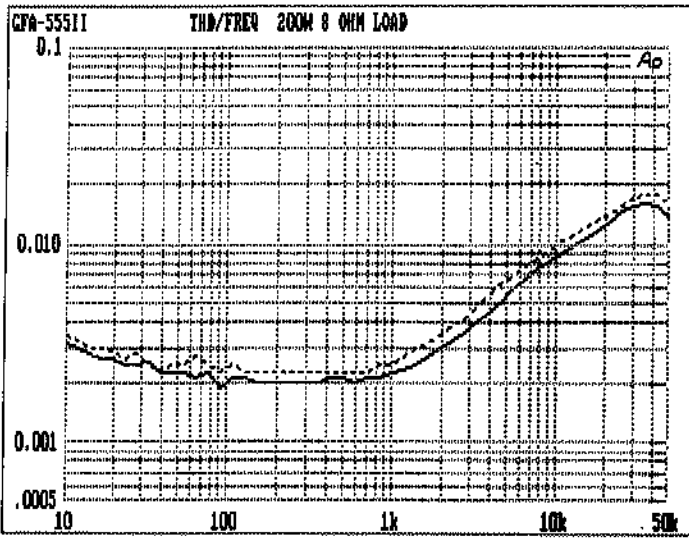

GFA-555II TYPICAL PERFORMANCE DATA

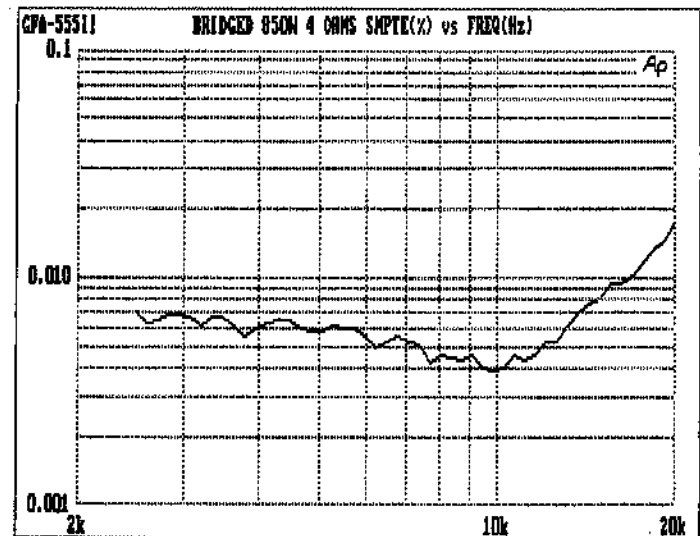
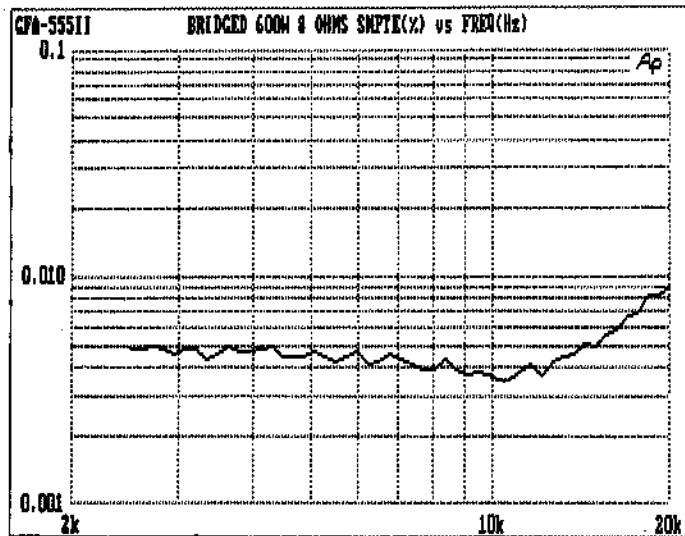
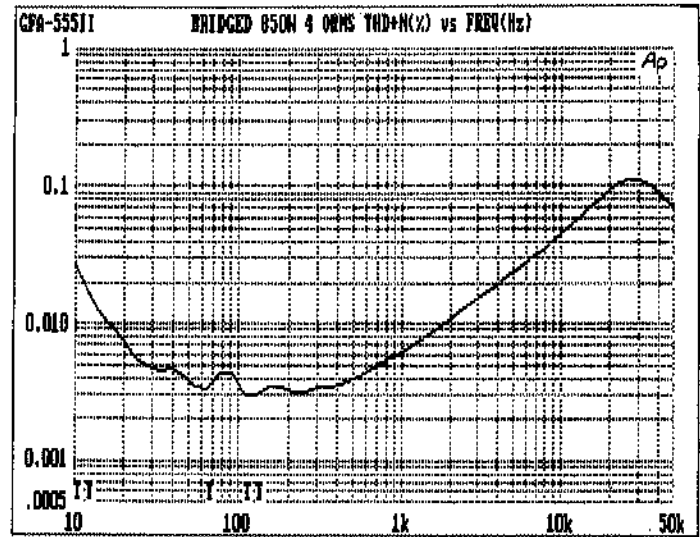
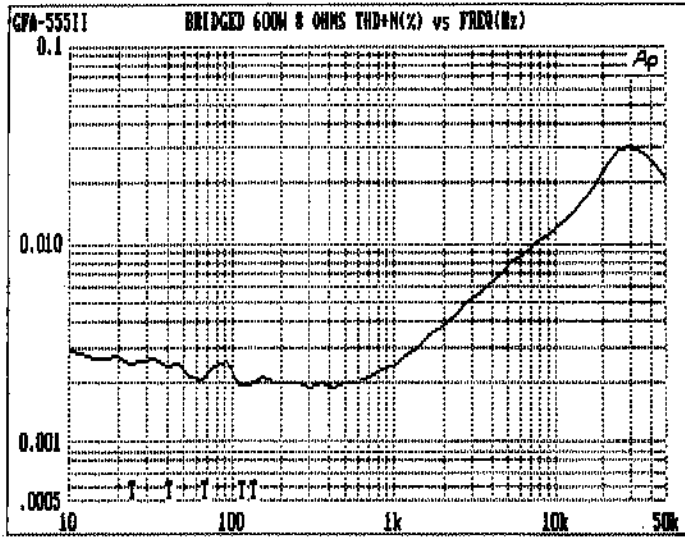
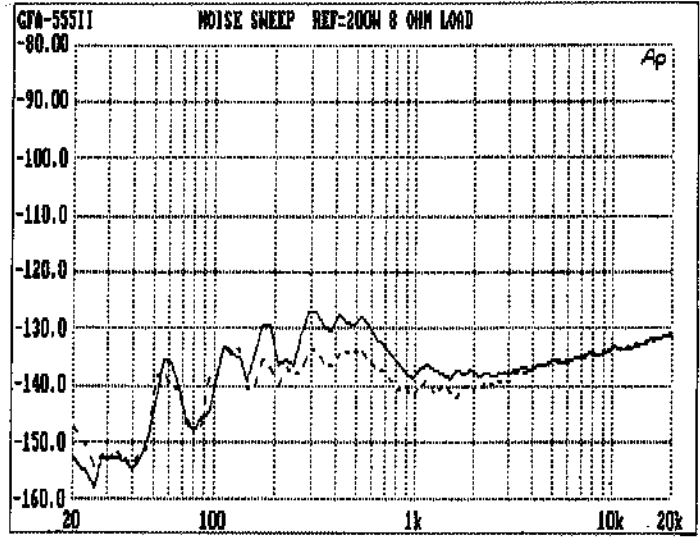
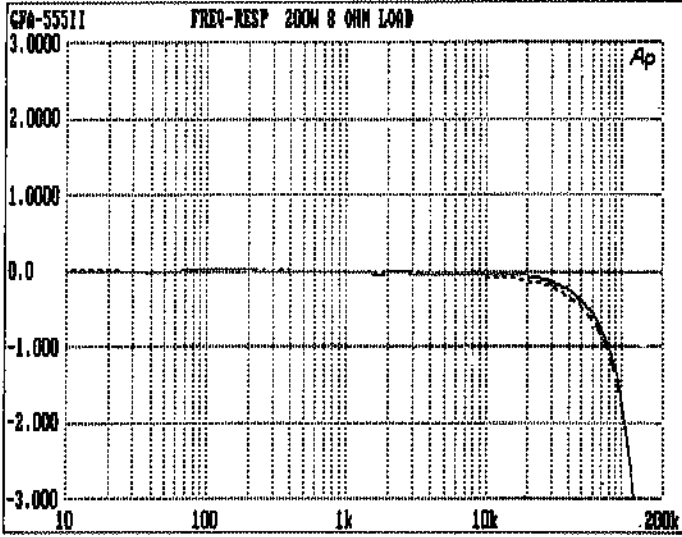

GFA-555II SPECIFICATIONS

Power Rating (To FTC Requirements)

200 watts continuous average power into 8 ohms at any frequency between 20Hz and 20kHz with both channels driven at less than 0.04% THD.

325 watts continuous average power into 4 ohms at any frequency between 20Hz and 20kHz with both channels driven at less than 0.04% THD.*

600 watts continuous average power into 8 ohms at any frequency between 20Hz and 20kHz at less than 0.09% THD, bridged.*

* With fan option installed.

IM Distortion (SMPTE)

1 watt to 200 watts into 8 Ohms ≤ 0.009%

1 watt to 325 watts into 4 Ohms ≤ 0.009%

IM Distortion (CCIF, Any Combination from 4kHz to 20kHz)

200 watts into 8 Ohms ≤ 0.002%

325 watts into 4 ohms ≤ 0.003%

THD + Noise at 200 Watts into 8 Ohms

20Hz 0.004%

1kHz 0.003%

10kHz 0.006%

20kHz 0.010%

THD + Noise at 325 Watts into 4 Ohms

20Hz 0.005%

1kHz 0.004%

10kHz 0.015%

20kHz 0.025%

IM Distortion, Bridged (SMPTE)

1 watt to 600 watts into 8 Ohms ≤ 0.05%

1 watt to 850 watts into 4 Ohms ≤ 0.05%

IM Distortion, Bridged (CCIF, Any Combination from 4kHz to 20kHz)

600 watts into 8 Ohms ≤ 0.005%

850 watts into 4 Ohms ≤ 0.005%

THD + Noise at 600 Watts into 8 Ohms, Bridged

20Hz 0.004%

1kHz 0.004%

10kHz 0.02%

20kHz 0.04%

THD + Noise at 850 Watts into 4 Ohms, Bridged

20Hz 0.01%

1kHz 0.007%

10kHz 0.05%

20kHz 0.09%

Frequency Response @ 1 Watt into 8 Ohms

10Hz to 20kHz +0, -0.25dB

Power Bandwidth (-3dB) 1.7Hz to 100kHz

Dynamic Headroom into 4 Ohms 2.5dB

Signal-to-Noise Ratio, "A" Weighted

200 watts into 8 Ohms ≥110dB

Gain 27dB

Input Impedance 100,000 ohms

Input Sensitivity	
200 watts into 8 Ohms	1.75V rms
1 watt into 8 Ohms	130mV rms
Damping Factor	
20Hz to 20kHz	≥ 800
Rise Time	
5kHz, 120V peak-to-peak square wave, 20% to 80%	2.3us
Semiconductor Complement	42 transistors, 2 zener diodes, 13 diodes, 2 ICs, 2 diode bridges
Power Consumption (Continuous, Both Channels Driven)	
Quiescent	72VA
Maximum	1500VA
200 watts into 8 Ohms	675VA
325 watts into 4 Ohms	1180VA
600 watts into 8 Ohms, bridged	1320VA

GENERAL

Power (available in 220V or 240V on special order)	120VAC/50-60Hz
Chassis Dimensions	6¾"(172mm) x 17"(432mm) x 12 ³ / ₁₆ "(310mm)
Maximum Dimensions	7¼"(185mm) x 17"(432mm) x 12 ³ / ₁₆ "(310mm)
Weight	35 lbs. (16kg)
Weight, Packed	39 lbs. (18kg)

ADCOM®

ADCOM Service Corp.	(732) 683-2356
10 Timber Lane	Mon. Thru Fri.
Marlboro, NJ	9 AM to 4 PM
07746	Eastern Time

SCHEMATIC DIAGRAM GFA-555II

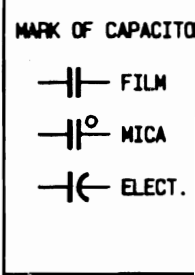
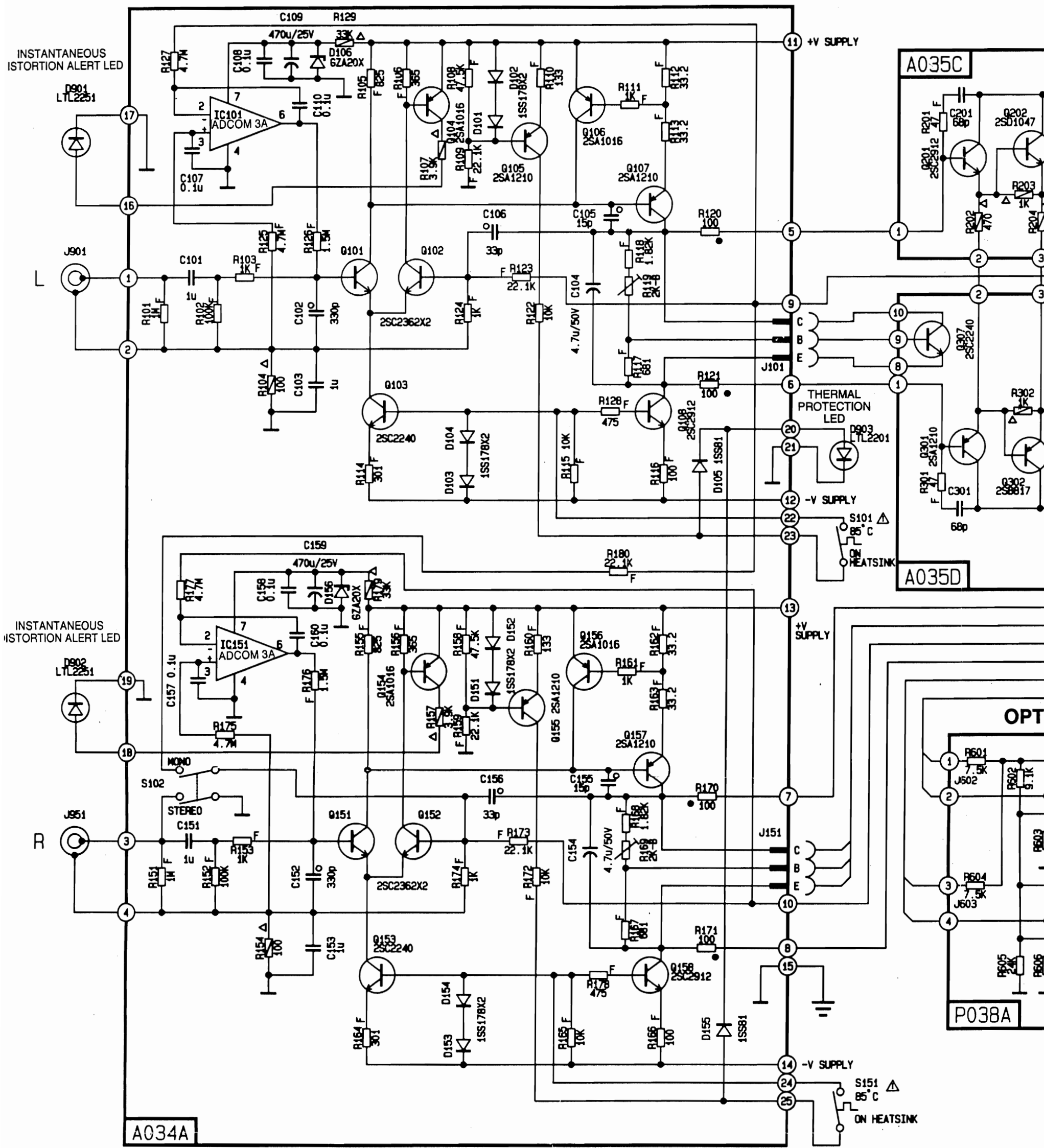

NOTE: ADCOM RESERVES THE RIGHT TO MODIFY CIRCUITRY AND/OR CHANGE COMPONENTS TO UPGRADE PRODUCT WITHOUT PRIOR NOTICE OR INCURRING ANY LIABILITY

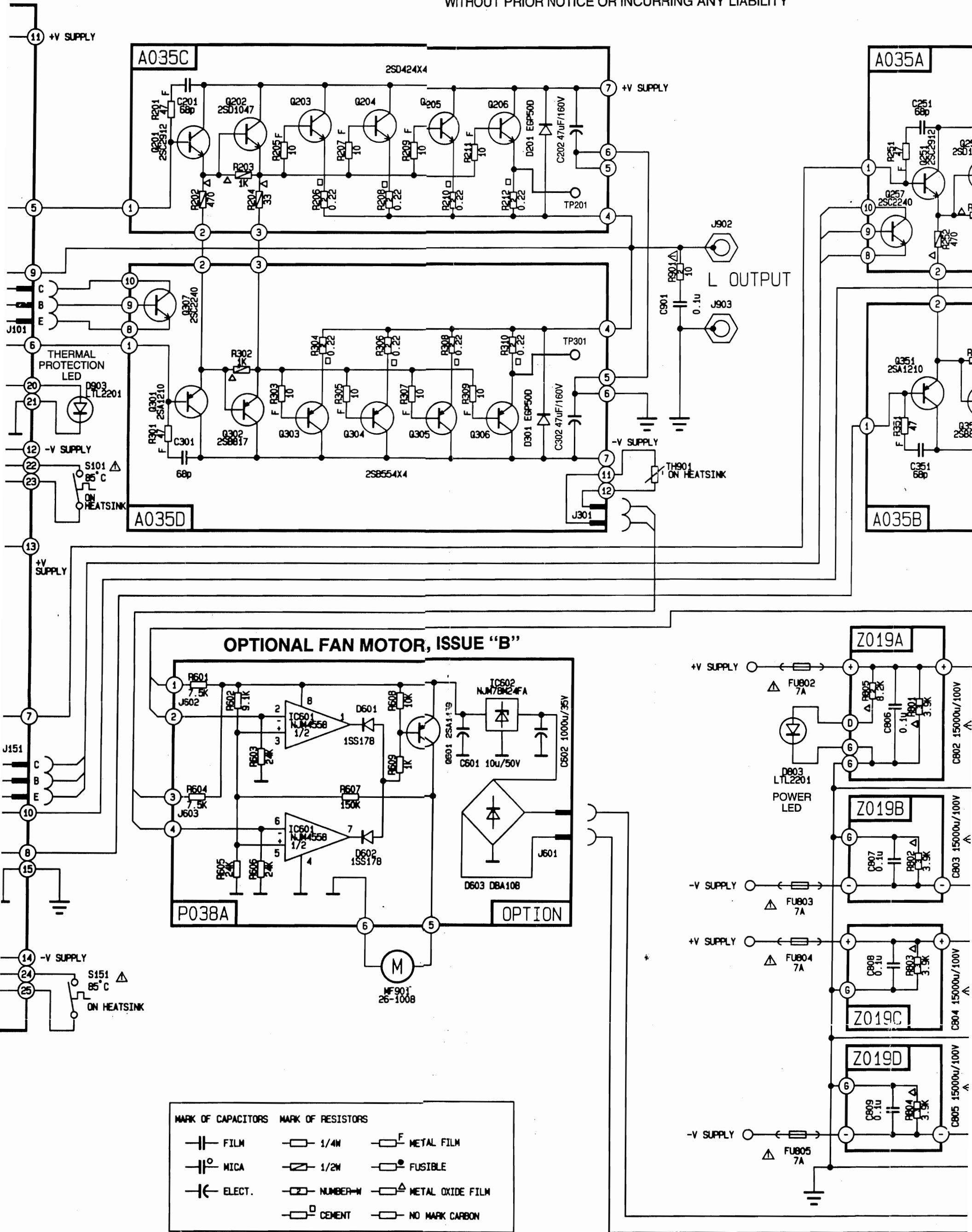

MODIFY CIRCUITRY
 UPGRADE PRODUCT
 RING ANY LIABILITY

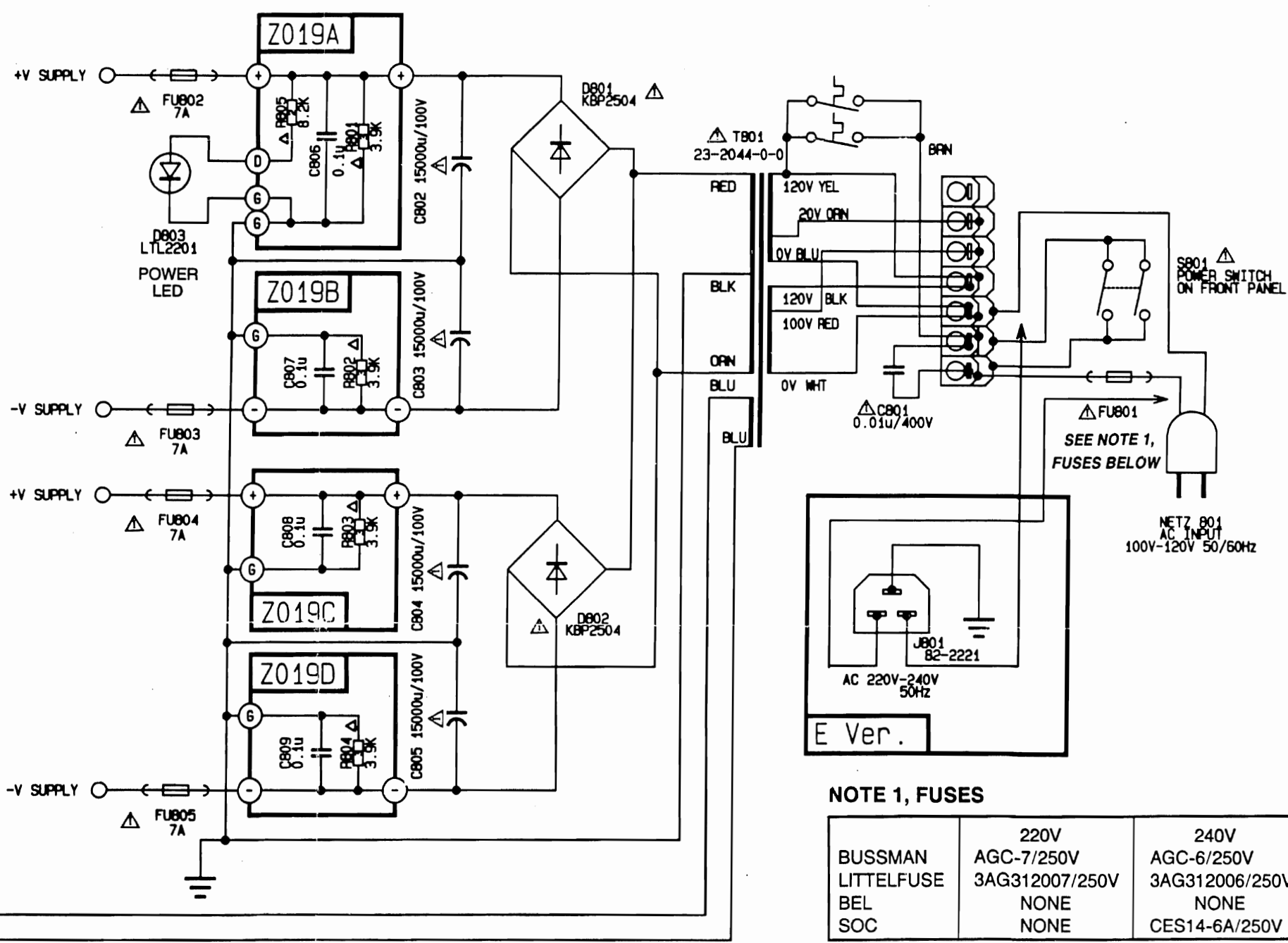
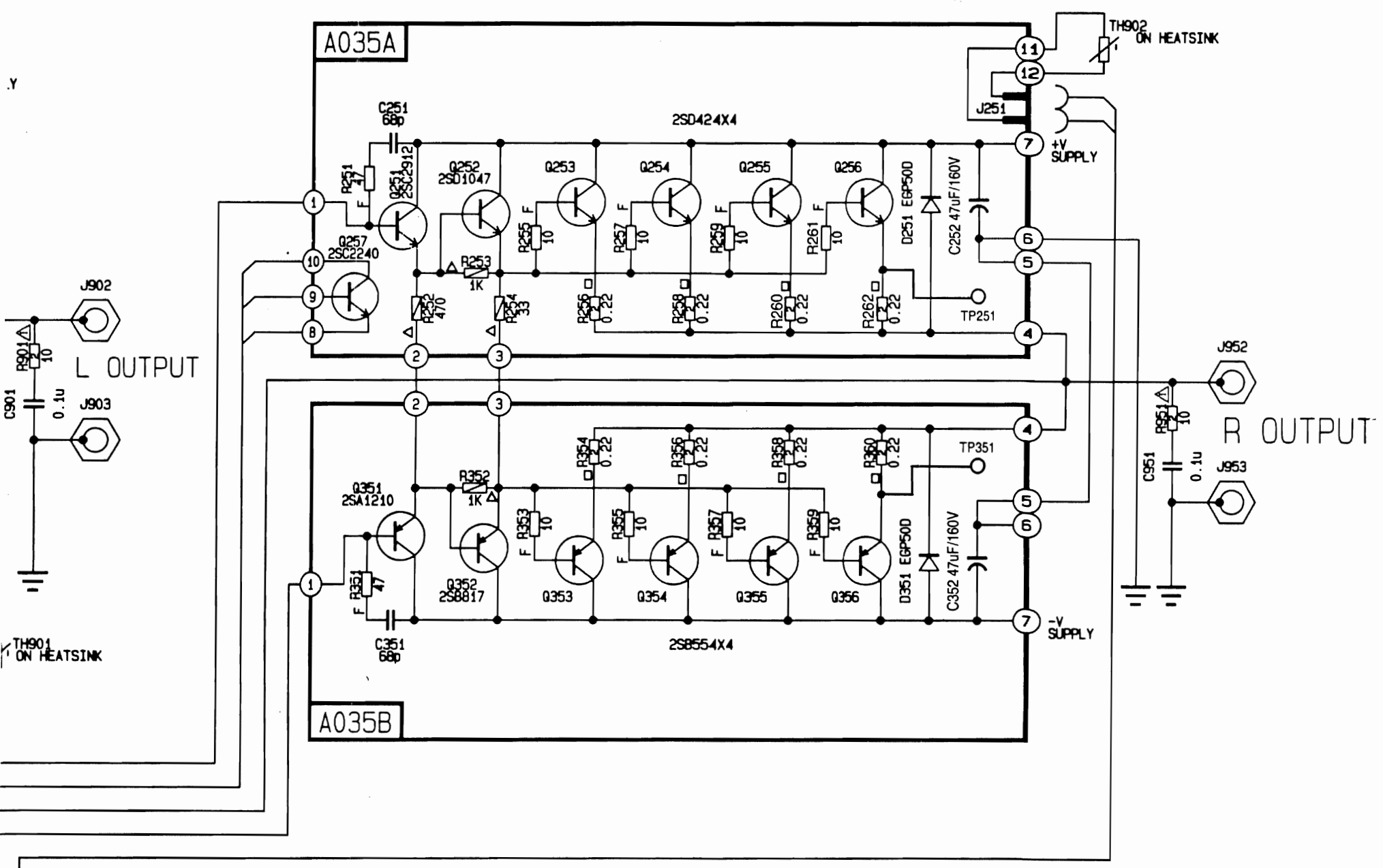

NOTE 1, FUSES

BUSSMAN	220V AGC-7/250V	240V AGC-6/250V
LITTELFUSE	3AG312007/250V	3AG312006/250V
BEL	NONE	NONE
SOC	NONE	CES14-6A/250V